



con la fotocamera del tuo smartphone inquadra e digita questo QRcode per consultare il listino prezzi al pubblico

RICAMBI COMPATIBILI

16

RICAMBI PER ROBOT TAGLIAERBA

RB 5310



RB 9310



RB 5522



RB 5310

Cavo perimetrale Premium - Bobina da 200 m - Diametro esterno 2,45 mm - Anima in rame - Area conduzione 0,933 mm²
 Numero di fili conduttori: 19 - Spessore isolamento: 0,6 mm - Resistenza per 500 m: 9,4 Ohm

RB 9310

Cavo perimetrale Premium - Bobina da 500 m - Diametro esterno 2,45 mm - Anima in rame - Area conduzione 0,933 mm²
 Numero di fili conduttori: 19 - Spessore isolamento: 0,6 mm - Resistenza per 500 m: 9,4 Ohm

RB 5522

Cavo perimetrale Premium Plus - Bobina 700 m - Diametro esterno 3,45 mm - Anima in rame - Area conduzione 0,933 mm²
 Numero di fili conduttori: 19 - Spessore isolamento: 1,1 mm - Resistenza per 500 m: 9,4 Ohm

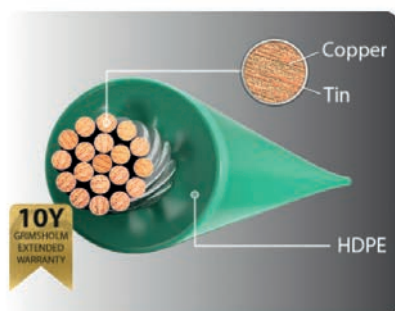

Premium



RB 5310
 Premium
 200 metri

Specification:
 Outer diameter: 2.45 mm
 Conductor area: 0.93 mm²
 Insulation: HDPE
 Conductor material: Tinned copper

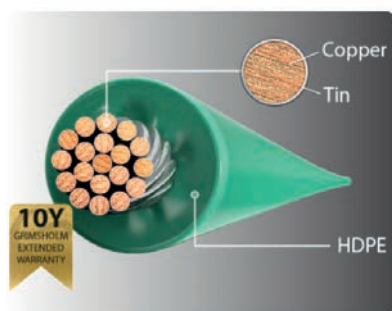

Premium



RB 9310
 Premium
 500 metri

Specification:
 Outer diameter: 2.45 mm
 Conductor area: 0.93 mm²
 Insulation: HDPE
 Conductor material: Tinned copper

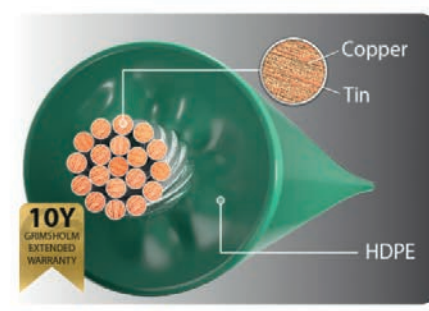

Premium Plus



RB 5522
 Premium Plus
 700 metri

Specification:
 Outer diameter: 3.45 mm
 Conductor area: 0.93 mm²
 Insulation: HDPE
 Conductor material: Tinned copper

RICAMBI PER ROBOT TAGLIAERBA

RB 1510



Attenzione:
i prezzi di listino dei ricambi per robot tagliaerba
si intendono sempre per singola unità.

RB 1510

Picchetti in nylon ultraresistente
per cavo perimetrale
Imballo minimo obbligatorio 100 pz

RB 5120



RB 5120

Connettore/giunto
per cavo perimetrale
3M-314
Imballo minimo
obbligatorio 50 pz

RB 1593



RB 2593



RB 1593

Connettore 2,7 mm 3M-951
Imballo minimo obbligatorio 10 pz

RB 2593

Connettore 3,4 ~ 4,2 mm 3M-952
Imballo minimo obbligatorio 10 pz

RB 1610



RB 1610
Giunti termici
Imballo minimo
obbligatorio 4 pz

RB 3610
Prolunghe
giunti termici
Imballo minimo
obbligatorio 4 pz



RB 3610



RICAMBI PER ROBOT TAGLIAERBA

RB 2210



RB 3210



RB 4110



RB 2100



RB 1010



RB 2210

Lama di ricambio 25 cm compatibile con robot Ambrogio, Stiga Autoclip, Wiper

RB 3210

Lama di ricambio 29 cm compatibile con robot Ambrogio, Stiga Autoclip, Wiper

RB 4110

Lama di ricambio compatibile con robot Honda Mimo
Imballo minimo obbligatorio 9 pz

RB 2100

Lama di ricambio compatibile con robot Worx
Imballo minimo obbligatorio 12 pz

RB 1010

Lama di ricambio compatibile con robot Automower
Imballo minimo obbligatorio 9 pz

RB 5140



RB 5140



RB 5140

Tester rilevatore guasti o rotture per cavo perimetrale - Modello universale



RICAMBI PER ROBOT TAGLIAERBA



RB 1450
Coprizzazione universale - Adattabile a tutti i robot con esclusione della linea Worx

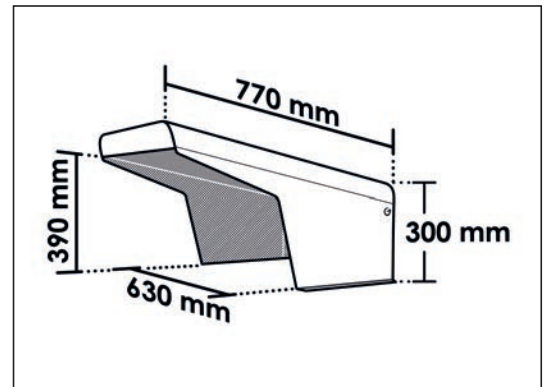

RB 7500 Modulo quadrato 100x100 cm di prato sintetico - Erba ibrida

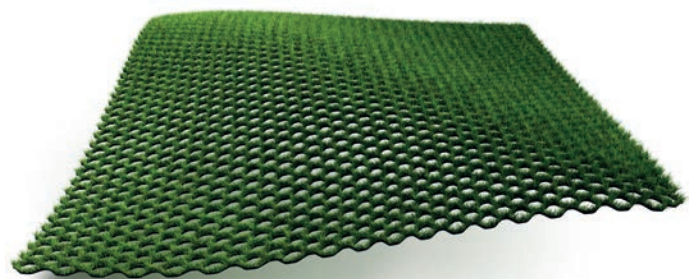
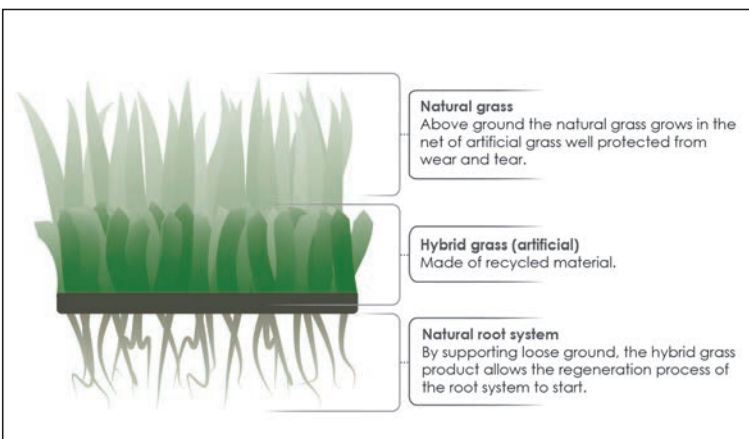

SPINE E COPPIGLIE

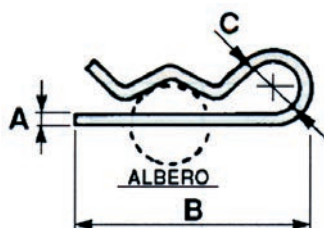
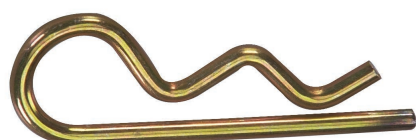
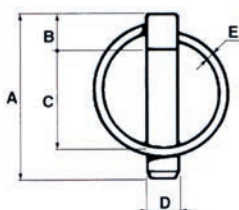

codice	D (mm)	A (mm)	B (mm)	C (mm)	E (mm)	Ø albero mm.
SS 45	4,5	45	9	29	2,5	da 10 a 15
SS 50	5	48	8,5	35	2,5	da 14 a 18
SS 60	6	55	8,5	36,5	3	da 18 a 22
SS 80	8	54	9	36,5	3	da 24 a 30
SS 90	9	55	11	36,5	3,5	da 26 a 32
SS 100	10	56	12	40	3,5	da 28 a 36
SS 110	11	56	11	40	3,5	da 30 a 38

codice	A (mm)	Ø albero (mm)	B (mm)	C (mm)
CP 18	1,8	da 6 a 8	35	6,5
CP 20	2	da 10 a 12	50	12
CP 25	2,5	da 11 a 13	58	14
CP 30	3	da 12 a 16	61	18
CP 35	3,5	da 15 a 21	80	18
CP 40	4	da 16 a 30	76	18
CP 50	5	da 20 a 35	100	24
CP 60	6	da 28 a 45	114	24



Confezionato in buste da 100 pezzi

SS 082250

Box espositore con 210 o-ring
Misure assortite

CP 081500

Box espositore con 150 spine
Misure assortite

FILTRI PESCA-MISCELA

PS 32 T



PS 57 T



PS 42 Z



PS 54 W



PS 14 BF — PS 15 BF



PS 32 T Pescanti mix - Filtro Tillotson in Panno - mm 3,2 x 15 x 26

PS 57 T Pescanti mix - Filtro Tillotson in Panno - mm 5,7 x 21 x 29

PS 42 Z Pescanti mix - Filtro Zama ZF1 - mm 4,2 x 13 x 20

PS 54 W Pescanti mix - Filtro Walbro - mm 5,4 (per motori fino a 30 cc)

PS 14 BF Pescanti mix - Filtro compatibile - mm 15x22 (fino a 45 cc)

PS 15 BF Pescanti mix - Filtro originale Walbro - mm 15x22 (fino a 45 cc)



FILTRI PESCA-MISCELA

PS X 34 Filtro pesca-miscela tipo POREX per decespugliatore
Attacco mm 3,5 - Dimensioni mm 15 x mm 19h

PS X 35 Filtro pesca-miscela tipo POREX
Attacco mm 3,5 - Dimensioni mm 20 x mm 29h

PS X 45 Filtro pesca-miscela tipo POREX
Attacco mm 4,5 - Dimensioni mm 20 x mm 29h

PS X 63 Filtro pesca-miscela tipo POREX
Attacco mm 6,3 - Dimensioni mm 20 x mm 29h

PS M 35 Filtro pesca-miscela con supporto metallico
Attacco mm 3,5 - Dimensioni mm 12 x mm 26h

PS M 45 Filtro pesca-miscela con supporto metallico
Attacco mm 4,5 - Dimensioni mm 12 x mm 26h

PS M 63 Filtro pesca-miscela con supporto metallico
Attacco mm 6,3 - Dimensioni mm 12 x mm 26h

PS MR 50 Cartuccia filtrante di ricambio mm 12 x mm 26h

PS P 35 Filtro pesca-miscela professionale a doppio filtraggio
Attacco mm 3,5 - Dimensioni mm 19 x mm 38h

PS P 45 Filtro pesca-miscela professionale a doppio filtraggio
Attacco mm 4,5 - Dimensioni mm 19 x mm 38h

PS P 63 Filtro pesca-miscela professionale a doppio filtraggio
Attacco mm 6,3 - Dimensioni mm 19 x mm 38h

PS PR 51 Cartuccia filtrante di ricambio mm 12 x mm 30h

PS G 35 Filtro pesca-miscela professionale a doppio filtraggio
Attacco mm 3,5 - Dimensioni mm 22 x mm 34h

PS G 45 Filtro pesca-miscela professionale a doppio filtraggio
Attacco mm 4,5 - Dimensioni mm 22 x mm 34h

PS G 63 Filtro pesca-miscela professionale a doppio filtraggio
Attacco mm 6,3 - Dimensioni mm 22 x mm 34h

PS GR 52 Cartuccia filtrante di ricambio mm 14 x mm 30h

PESCANTI IN POREX



SUPPORTO METALLICO



DOPPIO FILTRO PRO piccolo



DOPPIO FILTRO PRO grande





TUBI MISCELA

Tubo per miscela in vinile trasparente di colore giallo

Temperatura 70°C valore medio, -70°C valore minimo, +110°C valore massimo

Durezza ASTM D 2240, DIN 53505, Shore A 87

Carico di rottura ASTM D 638, DIN 53504, Mpa 46 - Allungamento ASTM 638, DIN 53504, 600%

Resistenza benzina senza piombo SIS 9210 Ø L 0% - Resistenza benzina senza piombo SIS 9210 Ø Sh A ±1



2,4

MS 2448 15 Tubo miscela giallo Valgarden in rotoli da metri 15
Diametro interno mm 2,4 - Diametro esterno mm 4,8

MS 3253 15 Tubo miscela giallo Valgarden in rotoli da metri 15
Diametro interno mm 3,2 - Diametro esterno mm 5,3

MS 3262 15 Tubo miscela giallo Valgarden in rotoli da metri 15
Diametro interno mm 3,2 - Diametro esterno mm 6,2

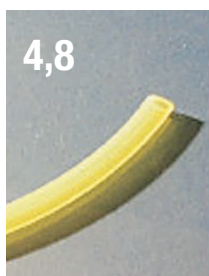

4,8

MS 4880 15 Tubo miscela giallo Valgarden in rotoli da metri 15
Diametro interno mm 4,8 - Diametro esterno mm 8,0

MS 6090 15 Tubo miscela giallo Valgarden in rotoli da metri 15
Diametro interno mm 6,0 - Diametro esterno mm 9,0



3,2

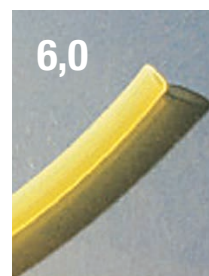

6,0



Tubo per miscela **TYGON** - Made in USA
Tubo speciale in vinile trasparente
che consente di controllare il flusso del carburante

TY 24 15 Tubo mix TYGON in rotoli da 15,2 metri
diametro interno mm 2,4 - esterno mm 4,8

TY 32 15 Tubo mix TYGON in rotoli da 15,2 metri
diametro interno mm 3,2 - esterno mm 6,4

TY 48 15 Tubo mix TYGON in rotoli da 15,2 metri
diametro interno mm 4,8 - esterno mm 8,0

PRIMER

HP 5567



HP 5567
Primer pompante
Walbro 224240
Larghezza base mm 21
Largh.intermedia mm 15
Altezza mm 33

HP 7605



HP 7605
Primer pompante
Kawasaki TH-23 TH-34
Larghezza base mm 19
Largh.intermedia mm 15
Altezza mm 16

KWR 502002034

HP 9151



HP 9151
Primer pompante
49043-2065
Larghezza base mm 18
Altezza mm 20

HP 0595



HP 0595
Primer pompante
Briggs Stratton 49615
Larghezza base mm 26
Altezza mm 24

HP 3181



HP 3181
Primer pompante
TLE24VDE-715
TLE33FD-101
Larghezza base mm 19
Largh.intermedia mm 16
Altezza mm 14

HP 1595



HP 1595
Primer pompante
Briggs Stratton 494408
Larghezza base mm 26
Altezza mm 19

HP 9642



HP 9642
Valvolina carburatore
Kawasaki TH-43 TH-48
Larghezza base mm 10
Altezza mm 6

HP 4795



HP 4795
Primer pompante
Walbro WZ 188-11
Larghezza base mm 19
Largh.intermedia mm 16
Altezza mm 11

HP 6795



HP 6795 Primer
Walbro HDA WYK 188-33
Kawasaki TH-43 TH-48
Larghezza base mm 23
Largh.intermedia mm 19
Altezza mm 16

KWR 502002043

HP 5795



HP 5795 Primer
WA WT WY WYJ WYK WYL
TJ-27/35/45/53
Larghezza base mm 19
Largh.intermedia mm 15
Altezza mm 14

KWR 502002027

HP 1344



HP 1344
Primer pompante
Walbro 188-513
Largh.intermedia mm 15
Altezza mm 29,5

HP 7795



HP 7795
Primer pompante
Zama C1U C1Q
Larghezza base mm 22
Largh.intermedia mm 18
Altezza mm 18



PO 360 A Pompa Olio adattabile ad Alpina-Castor P360 - 370 - 390 - 410

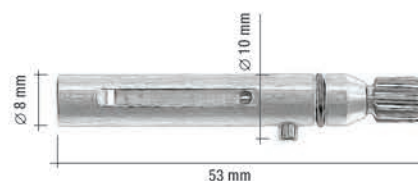

Lunghezza mm 53

Larghezza mm 8

PO 400 A Pompa Olio adattabile ad Alpina-Castor 400 - 450 - 460 - 500 - 510

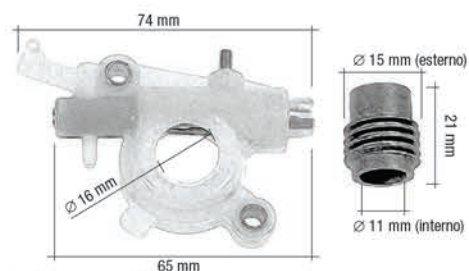

Larghezza mm 74

PO 260 E Pompa Olio adattabile ad Echo 2600 e simili



PO 260 E IP
Ingranaggio Pompa Olio

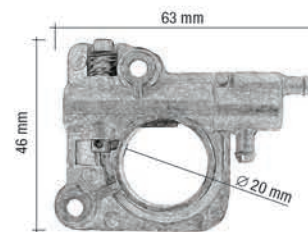

Larghezza mm 63

Larghezza mm 46

PO 302 E Pompa Olio adattabile ad Echo 302 - 304 - 315 - 330 - 351 - 360 - 400 - 440 - 452 - 500

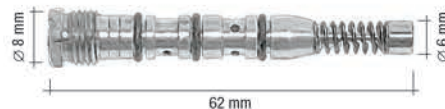

Larghezza mm 62

Larghezza mm 8

PO 136 H Pompa Olio adattabile ad Husqvarna 36 - 41 - 136 - 141 e simili

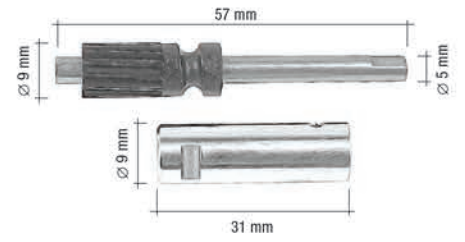

Larghezza mm 58

Larghezza mm 9

PO 340 H Pompa Olio adattabile ad Husqvarna 340 - 345 e simili

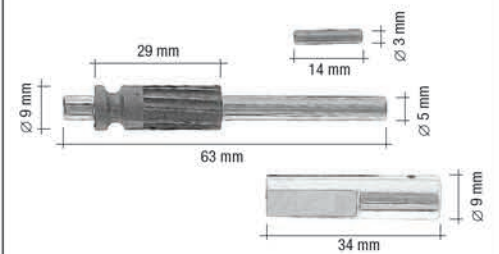
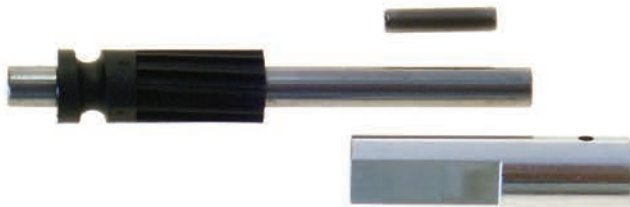

Larghezza mm 65

Larghezza mm 9

PO 400 H Pompa Olio adattabile ad Husqvarna 40 - 45 e simili

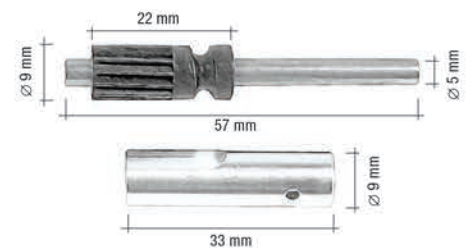

Larghezza mm 60

Larghezza mm 9

PO 500 H Pompa Olio adattabile ad Husqvarna 50 - 51 - 55 e simili

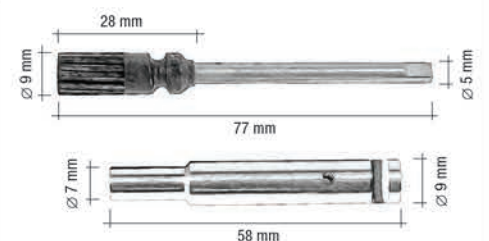

Larghezza mm 86

Larghezza mm 9

PO 335 M Pompa Olio adattabile a Mc Culloch Mac 335

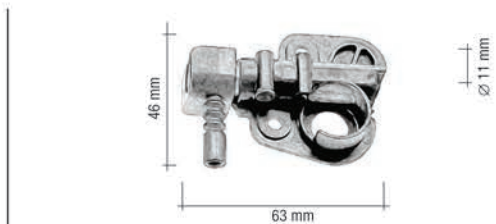

Larghezza mm 63

Larghezza mm 46

PO 251 O Pompa Olio adattabile ad Oleo Mac 251 - 252 - 254 - 261 - 262 - 350 - 355 e simili

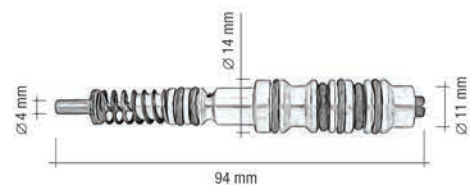

Larghezza mm 94

Larghezza mm 14

PO 931 O Pompa Olio adattabile ad Oleo Mac 131 - 132 - 931 - 932 e simili



PO 931 O IP
Ingranaggio Pompa Olio

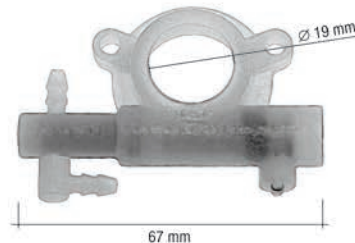

Larghezza mm 67

PO 935 O Pompa Olio adattabile a Oleo Mac 135 - 935 e simili

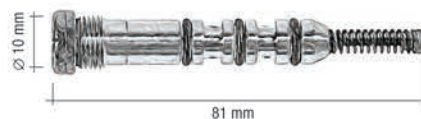

Larghezza mm 81

Larghezza mm 10

PO 936 O Pompa Olio adattabile a Oleo Mac 136 - 140 - 936 - 940 e simili



PO 936 O IP
Ingranaggio Pompa Olio

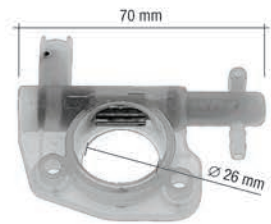
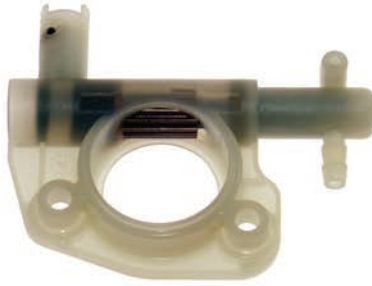

Larghezza mm 70

PO 938 O Pompa Olio adattabile ad Oleo Mac 142 - 146 - 151 - 942 - 946 - 951

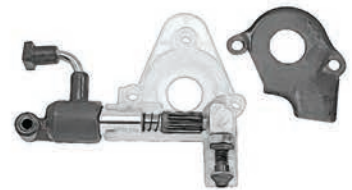

Larghezza mm 200

Larghezza mm 200

PO 170 S Pompa Olio adattabile a Stihl 017-018-021-023-025-170-171-180-181-210-211-230-250

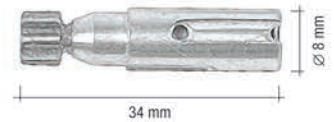

Larghezza mm 34

Larghezza mm 8

PO 250 Z Pompa Olio adattabile a Zenoah GT250 e varie da potatura ...



PO 250 Z IP
Ingranaggio Pompa Olio



Larghezza mm 58

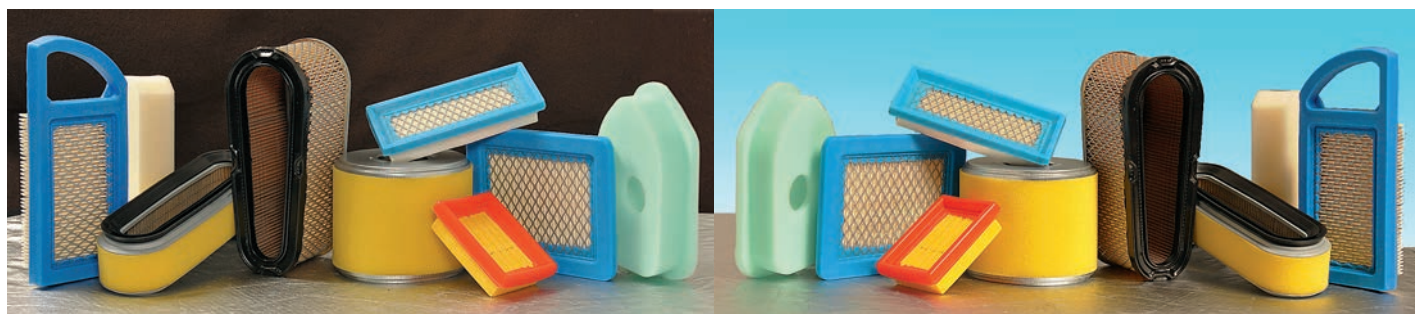

FM 1 634 Adattabile a motori Briggs 10G con carburatore a membrana e primer (698369)

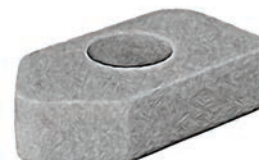

Lunghezza mm 120
Larghezza mm 70

Altezza mm 30
Ø foro mm 40

FM 1 522 Adattabile a motori Briggs Quantum da HP 3,5 a 6,0 - XM XTE (491588)



Lunghezza mm 130
Larghezza mm 110

Altezza mm 20

FM 1 241 Adattabile a motori Briggs modello Sprint, Classic e Quattro (272235)

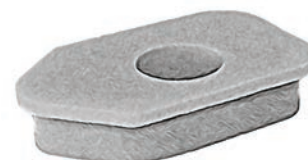

Lungh. superiore mm 150
Lungh. inferiore mm 135

Ø foro grande mm 40
Ø foro piccolo mm 21
Largh. sup. mm 81
Largh. inf. mm 71
Altezza mm 31

FM 1 496 Adattabile a motori Briggs Intek 60/65 (697029 ex 690610)

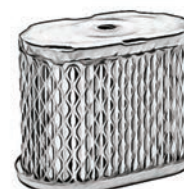

Lunghezza mm 95
Larghezza mm 55

Altezza mm 75

FM 1 746 Adattabile a motori Briggs AWS 21 (698413)

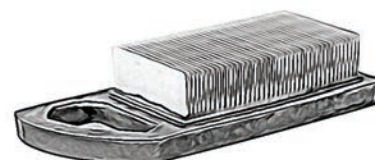

Lato lungo mm 180
Lato corto mm 150

Altezza mm 31
Larghezza mm 80

FM 1 012 Adattabile a motori Briggs per Trattorini HP 12,5 HP 13 (496894 - 493909)



Largh. lato stretto mm 21
Largh. lato largo mm 40

Altezza mm 71
Lunghezza mm 180

FM 1 302 Adattabile a motori Briggs AWS 28-31 (698083 - 697153)



Lato lungo mm 220
Lato corto mm 180

Altezza mm 38
Larghezza mm 71

FM 1 522 Adattabile a motori Honda GX-GXV 135-160 (17211ZL8000-17211ZL8003)



Lunghezza mm 130
Larghezza mm 110

Altezza mm 20

FM 2 920 Adattabile a motori Honda GXV 140 (17211ZG9-800)

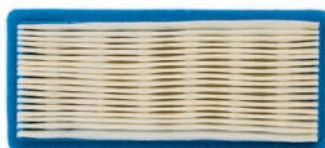

Lunghezza mm 130
Larghezza mm 60

Altezza mm 20

FM 2 591 Adattabile a motori Honda GX 140/160 (17210ZE1821-822)



Lunghezza mm 100
Larghezza mm 70

Altezza mm 70

FM 2 160 Adattabile a motori Honda GX-160

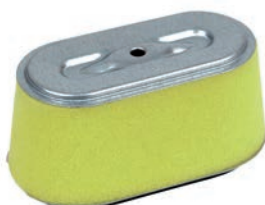

Lunghezza mm 119
Larghezza mm 68

Altezza mm 60
Diametro foro mm 6

FM 2 030 Adattabile a motori Honda GX 240/270/340/390 (17210ZE3010-17210ZE3000)



Lunghezza mm 110
Larghezza mm 91

Altezza mm 90

FM 3 842 Adattabile a motori Tecumseh Vantage BVS 143/153 (23410026)



Lunghezza mm 140
Larghezza mm 31

Altezza mm 20

FM 3 217 Adattabile a motori Tecumseh Synergy/Prisma (23410047 ex 23410031)

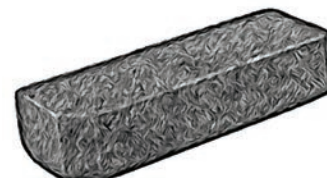

Lunghezza mm 150
Larghezza mm 41

Altezza mm 30

FM 4 280 Filtro Spugna adattabile a motori Kawasaki (3104011312)

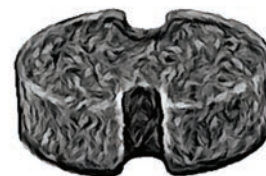

Diametro mm 41

Altezza mm 10

FM 4 340 Adattabile a motori Kawasaki FJ180V (110297010 - 110137010)



Lato lungo mm 211
Lato corto mm 181

Larghezza mm 61
Altezza mm 30

FM 5 630 Adattabile a decespugliatori Stihl FS350/450 FR450 (41341410300)

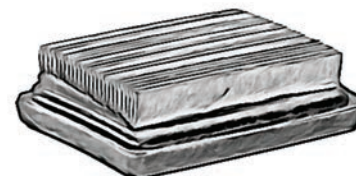

Lunghezza mm 81
Larghezza mm 70

Altezza mm 21

FM 9 517 Filtro aria generico per Decespugliatori cc 26/33/43



Perimetro esterno mm 60
Perimetro interno mm 40

Altezza mm 11

FM 9 788 Filtro aria adattabile a carburatori Walbro WZ



Diametro esterno mm 30
Diametro interno mm 21

Altezza mm 21

FM 9 634 Filtro Benzina adattabile a Trattorini (691035 ex 493629)



Diametro esterno mm 35
Attacco mm 7 - 1/4" - 5/16"

Altezza totale
mm 73

FM 9 828 Filtro aria completo adattabile a motori 2T per Decespugliatori e Motopompe



Lato lungo mm 80
Lato corto mm 60

Altezza mm 31

FM 9 338 Filtro in Spugna - Ricambio per filtro FM 9828



Diametro interno mm 30
Diametro esterno mm 51

Altezza mm 21

FM 6 161 Filtro aria compatibile con motori Briggs & Stratton - Codice di riferimento 792038



FM 6 168 Filtro aria compatibile con motori Briggs & Stratton - Codice di riferimento 798452 - 593260



FM 6 183 Filtro aria compatibile con motori Briggs & Stratton - Codice di riferimento 799579



FM 6 851 Filtro aria compatibile con motori Briggs & Stratton - Codice di riferimento 594201 - 591334



FM 6 852 Filtro aria compatibile con motori Briggs & Stratton - Codice di riferimento 796032 - 591583



FM 6 540 Filtro aria compatibile con motori di importazione - Codice di riferimento NGP T475-110



FM 6 180 Filtro aria compatibile motori Kawasaki
110137049 110130726 110130752 110137047



FM 6 171 Filtro aria compatibile motori Kawasaki
1102907001 110137009



FM 7 090 Filtro olio compatibile con motori
Briggs & Stratton - Codice 696854



FM 7 130 Filtro olio compatibile con motori
Briggs & Stratton - Codice 492932



FM 7 072 Filtro olio compatibile motori Kawasaki
Codice 490652078 - 490652071 - 26165902



FM 7 454 Filtro olio compatibile con motori
Husqvarna 586666801 - 187Q0526460



CONSULTARE IL CATALOGO RICAMBI **Kawasaki**

<p>FILTRO ARIA compatibile TJ-27</p> <p>KWR 110130027</p> <p>KWR 110130027</p>	<p>FILTRO ARIA compatibile TJ-35</p> <p>KWR 110130035</p> <p>KWR 110130035</p>	<p>FILTRO ARIA compatibile TJ-45</p> <p>KWR 110130045</p> <p>KWR 110130045</p>	<p>FILTRO ARIA compatibile TJ-53</p> <p>KWR 110130053</p> <p>KWR 110130053</p>	<p>FILTRO ARIA compatibile TH-34</p> <p>KWR 110130034</p> <p>KWR 110130034</p>	<p>FILTRO ARIA comp. TH-43 TH-48</p> <p>KWR 110134348</p> <p>KWR 110134348</p>
--	--	--	--	--	--



TAPPI DI RICAMBIO

TP 1 820 ø interno mm 37
Altezza mm 23



Adatt. Briggs Stratton primi tipi
rif.to codici 298425 - 493982

TP 1 130 ø interno mm 39
Altezza mm 24



Adatt. BS Sprint Classic Quattro
rif.to codici 497929

TP 1 920 ø interno mm 43
Altezza mm 19



Adattabile Briggs Max Quantum
rif.to codici 2397974 - 692046

TP 1 330 ø interno mm 48
Altezza mm 26



Adatt. Briggs Stratton 494559
ad albero orizzontale

TP 1 230 ø interno mm 52
Altezza mm 41



Adattabile Briggs Stratton
per trattorini HP 12 e vari

TP 0 510 Lunghezza
totale mm 44



Filtro combustibile adattabile a
Briggs Stratton e Toro

TP 2 430 ø interno mm 45
Altezza mm 39



Adattabile Serbatoi Honda
17620ZL8003 - GV GCV GX

TP 3 420 ø interno mm 38
Altezza mm 25



Adattabile Tecumseh primi tipi
23350019 - 23350001

TP 3 370 ø interno mm 36
Altezza mm 28



Adattabile serbatoi Tecumseh
modelli BVL

TP 3 620 ø interno mm 45
Altezza mm 29



Adattabile serbatoi Tecumseh
seconda versione 13350003

TP 2 318



Adattabile a serbatoi Honda
GXV 120 - GXV 160
17620ZE7000 2289833 18550001

TP 2 196



Adattabile a serbatoi Honda
GX 110 - GX 120 - GX 140 - GX 160

TP 2 125



Adattabile a serbatoi Honda
176200ZH7013

TP 2 126



Adattabile a serbatoi Honda
GX 120 - GX 160 17620ZH7023

TP 4 039



Compatibile motori Loncin
G200F - 170870039-0001

TP 4 040



Compatibile motori Loncin
G200F - 170870040-0001

TP 4 094



Compatibile motori Loncin
LC1P70FA - 170870094-0001

TP 5 970



Compatibile motori Stiga
118802097/0

TP 5 001



Compatibile motori Stiga
125795000/1

TP 5 011



Compatibile motori Stiga
125795001/1

TP 9 811

Ø interno mm 36
Altezza mm 24



Adattabile a serbatoi per
Decesp. Mitsubishi int. mm 36

TP 9 611

Ø interno mm 31
Altezza mm 22



Adattabile a serbatoi per
Decespugliatori Mitsubishi

TP 9 021

Ø interno mm 33
Altezza mm 21



Adattabile a serbatoi per
Dec Tanaka/Hitachi 5950650490

TP 9 041

Ø interno mm 38
Altezza mm 22



Adattabile a serbatoi per
Dec Tanaka/Hitachi 5950502490

TP 9 331

Ø interno mm 27
Altezza mm 16



Adattabile a serbatoi per
Decesp. Echo SRM 13100406320

TP 9 531

Ø interno mm 35
Altezza mm 19



Adattabile a serbatoi per
Dec Echo 13100440630 - 55830

TP 9 801

Ø interno mm 36
Altezza mm 44
completo di valvola sfiato



Adattabile a serbatoi per
Decesp. Kawasaki 510492057

TP 9 150

Ø mm 36
Lunghezza mm 40



Valvola sfiato per tappo TP 9801
per Dec. Kawasaki 140692056

TP 9 031

Ø interno mm 35
Altezza mm 20



Adattabile a serbatoi per
Decespugliatori (generici)

SPILLI CONICI

HS 4560



HS 4560
Spillo conico
per carburatore
HL WYL TLE33FD

HS 1666



HS 1666
Spillo conico
per carburatore
Briggs Hp 3,5/4,5

HS 9860



HS 9860
Spillo conico
per carburatore
HS HU HDA HDC WS

HS 5522



HS 5522
Spillo conico
per carburatore Walbro

HS 7341



HS 7341
Spillo conico
per carburatore
Honda GXV 160



SPILLO CONICO compatibile TJ-27



SPILLO CONICO compatibile
TJ-35 TJ-45 TJ-53 TH-34

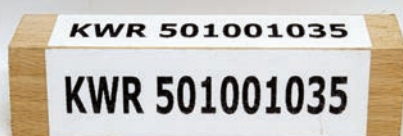

SPILLO CONICO compatibile
TH-43 TH-48





KIT MEMBRANE compatibili TJ-27

KWR 500000027

KIT MEMBRANE compatibili TJ-35 TJ-45 TJ-53

KWR 500000035

KIT MEMBRANE compatibili TH-34

KWR 500000034

KIT MEMBRANE compatibili TH-43 TH-48

KWR 500000043

KT 101 00

membrane e guarnizioni adattabili ai carburatori tipo **HU**

KT 102 00

Kit membrane TILLOTSON

membrane e guarnizioni adattabili ai carburatori tipo **HK**

KT 103 00

membrane e guarnizioni adattabili ai carburatori tipo **HS**

KT 103 98

membrane e guarnizioni complete di Kit riparazione adattabili ai carburatori tipo **HS rk**

Fotocopiare questa pagina con la funzione ingrandimento ZOOM 140 per avere la dimensione reale delle membrane e guarnizioni per carburatore

Kit membrane TILLOTSON



KT 104 00 membrane e guarnizioni adattabili ai carburatori tipo **HL 4E**



KT 104 97 membrane e guarnizioni complete di Kit riparazione adattabili ai carburatori tipo **HL 4E rk**



KT 105 00 membrane e guarnizioni adattabili ai carburatori tipo **HL 5E**

Fotocopiare questa pagina con la funzione ingrandimento ZOOM 140 per avere la dimensione reale delle membrane e guarnizioni per carburatore

Kit membrane WALBRO

KW 201 00
 membrane e guarnizioni
 adattabili ai carburatori tipo
WA USA

KW 201 95
 membrane e guarnizioni
 complete di Kit riparazione
 adattabili ai carburatori tipo
WA USA rk

KW 202 00
 membrane e guarnizioni
 adattabili ai carburatori tipo
WA JAPAN

KW 202 94
WA JAPAN rk

KW 203 00
 membrane e guarnizioni
 adattabili ai carburatori tipo
WAT 8

Fotocopiare questa pagina con la funzione ingrandimento ZOOM 140 per avere la dimensione reale delle membrane e guarnizioni per carburatore

Kit membrane WALBRO



KW 204 00

membrane e guarnizioni adattabili ai carburatori tipo

WAT 12



KW 206 00

membrane e guarnizioni adattabili ai carburatori tipo

WYK D13



KW 207 00

HDA



KW 207 98

HDA rk



KW 211 00

membrane e guarnizioni adattabili ai carburatori tipo

WA 148

Fotocopiare questa pagina con la funzione ingrandimento ZOOM 140 per avere la dimensione reale delle membrane e guarnizioni per carburatore

Kit membrane WALBRO

KW 212 00

membrane e guarnizioni
adattabili ai carburatori tipo
WAT D20

membrane e guarnizioni
complete di Kit riparazione
adattabili ai carburatori tipo

KW 212 91
WAT D20 rk

KW 214 00

membrane e guarnizioni
adattabili ai carburatori tipo
HDC

KW 215 00

SDC

membrane e guarnizioni
complete di Kit riparazione
adattabili ai carburatori tipo

KW 215 97
SDC rk

Fotocopiare questa pagina con la funzione ingrandimento ZOOM 140 per avere la dimensione reale delle membrane e guarnizioni per carburatore

Kit membrane WALBRO



KW 220 00

membrane e guarnizioni
adattabili ai carburatori tipo

WA 10AT

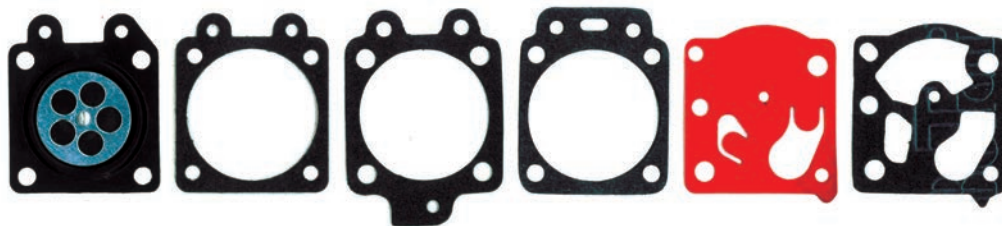

KW 221 00

membrane e guarnizioni
adattabili ai carburatori tipo

WT 238

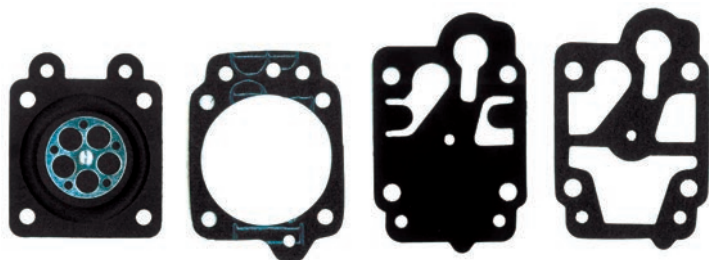

KW 222 00

membrane e guarnizioni
adattabili ai carburatori tipo

WA H4T



KW 224 00

membrane e guarnizioni
adattabili ai carburatori tipo

WAT D10



membrane e guarnizioni
complete di Kit riparazione
adattabili ai carburatori tipo

KW 224 99

WAT D10 rk

Fotocopiare questa pagina con la funzione ingrandimento ZOOM 140 per avere la dimensione reale delle membrane e guarnizioni per carburatore

Kit membrane WALBRO



KW MG

membrana e guarnizione
adattabile ai carburatori Walbro

Kit membrane ZAMA

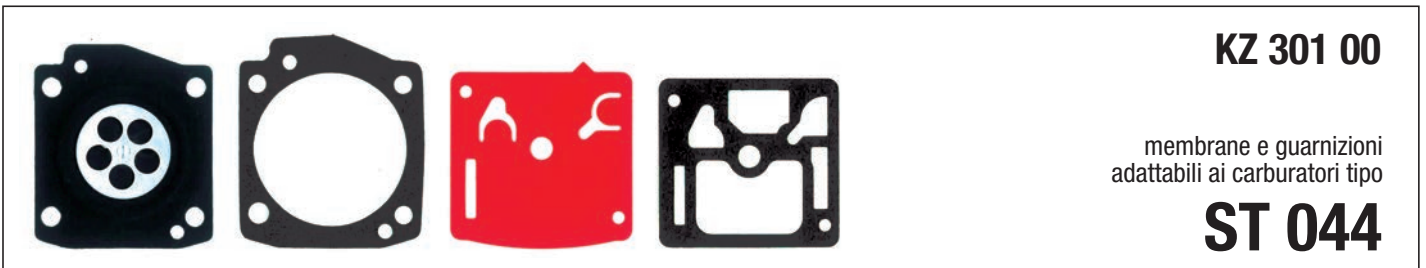

KZ 301 00

membrane e guarnizioni
adattabili ai carburatori tipo

ST 044

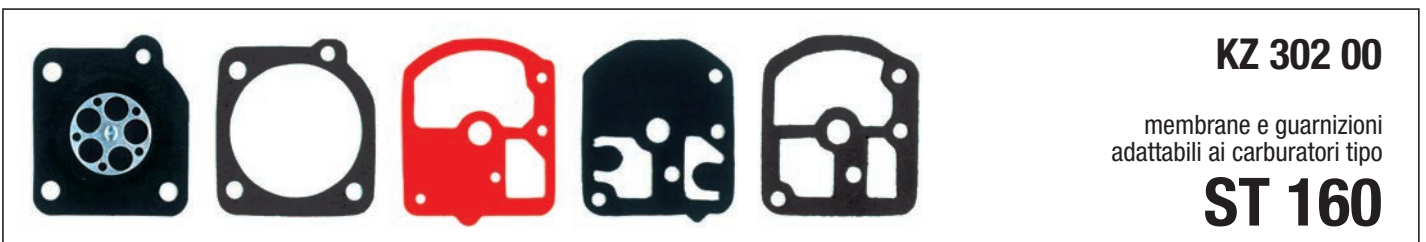

KZ 302 00

membrane e guarnizioni
adattabili ai carburatori tipo

ST 160



KZ 304 00

membrane e guarnizioni
adattabili ai carburatori tipo

C1Q E3

Fotocopiare questa pagina con la funzione ingrandimento ZOOM 140 per avere la dimensione reale delle membrane e guarnizioni per carburatore

Kit membrane ZAMA

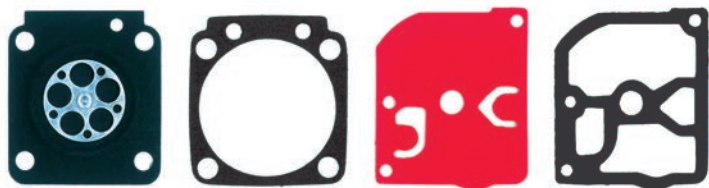

KZ 305 00

membrane e guarnizioni
adattabili ai carburatori tipo

QTY 1



KZ 306 00

membrane e guarnizioni
adattabili ai carburatori tipo

C 1 U

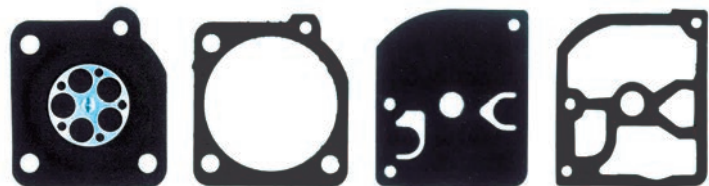

KZ 307 00

membrane e guarnizioni
adattabili ai carburatori tipo

1Q EL1



membrane e guarnizioni
complete di Kit riparazione
adattabili ai carburatori tipo

KZ 307 97

1Q EL1 rk



KZ 309 00

membrane e guarnizioni
adattabili ai carburatori tipo

C 1 Q

Fotocopiare questa pagina con la funzione ingrandimento ZOOM 140 per avere la dimensione reale delle membrane e guarnizioni per carburatore

Kit membrane TK JAPAN

KJ 401 00

membrane e guarnizioni
adattabili ai carburatori tipo

KAWA 24 33 40

KJ 402 00

membrane e guarnizioni
adattabili ai carburatori tipo

KAWA 43 48

KJ 403 00

membrane e guarnizioni
adattabili ai carburatori tipo

KAWA 23 26

KJ 404 00

membrane e guarnizioni
adattabili ai carburatori tipo

SDK T27 T300

KJ 406 00

membrane e guarnizioni
adattabili ai carburatori tipo

SDK T25

Fotocopiare questa pagina con la funzione ingrandimento ZOOM 140 per avere la dimensione reale delle membrane e guarnizioni per carburatore

CHIAVI CANDELA



CC 19 341

CC 19 350

Chiave candela a T 19 x 13 mm - Lunga a stella Torx

CC 19 341

Chiave candela a T 19 x 13 mm - Lunga tipo H

CC 19 349

Chiave candela a T 19 x 13 mm - Tradizionale

CC 19 353

Chiave candela a T 19 x 13 mm - Large

CC 16 342

Chiave candela a T 16 x 13 mm - Tradizionale

CC 19 350

CC 19 341

CC 19 349

CC 19 353



CC 16 342



CC 19 19

Snodata mm 19

CC 19 21

Snodata mm 21

CC 19 H

mm 19x13 tipo Husqvarna

CC 19

Tradizionale mm 19x13



C 19 19



C 19

CANDELE ACCENSIONE VALGARDEN

- CV 56** Candela Valgarden esagono 19 mm - Filetto 9,5 mm - n. 14 x 1,25 - Confezione 10 pz.
Compatibile NGK BM6A - Champion CJ8
- CV 65** Candela Valgarden esagono 21 mm - Filetto 12 mm - n. 14 x 1,25 - Confezione 10 pz.
Compatibile NGK B6HS - Champion L82 / L82 C



CANDELE ACCENSIONE NGK



B 2 LM	Esagono 21 mm	Filetto 9,5 mm	M 14 x 1,25	Conf.10 pz
B 4 LM	Esagono 21 mm	Filetto 9,5 mm	M 14 x 1,25	Conf.10 pz
B 6 HS	Esagono 21 mm	Filetto 12,0 mm	M 14 x 1,25	Conf.10 pz
B 6 S	Esagono 21 mm	Filetto 9,5 mm	M 14 x 1,25	Conf.10 pz
BCPR 5 ES	Esagono 16 mm	Filetto 19,0 mm	M 14 x 1,25	Conf.10 pz
BKR 5 ES	Esagono 16 mm	Filetto 19,0 mm	M 14 x 1,25	Conf.10 pz
BM 6 A	Esagono 19 mm	Filetto 9,5 mm	M 14 x 1,25	Conf.10 pz
BM 6 F	Esagono 16 mm	Filetto 9,5 mm	M 14 x 1,25	Conf.10 pz
BM 7 A	Esagono 19 mm	Filetto 9,5 mm	M 14 x 1,25	Conf.10 pz
BMR 6 A	Esagono 19 mm	Filetto 9,5 mm	M 14 x 1,25	Conf.10 pz
BP 5 ES	Esagono 21 mm	Filetto 19,0 mm	M 14 x 1,25	Conf.10 pz
BP 6 ES	Esagono 21 mm	Filetto 19,0 mm	M 14 x 1,25	Conf.10 pz
BPM 6 A	Esagono 19 mm	Filetto 9,5 mm	M 14 x 1,25	Conf.10 pz
BPM 6 Y	Esagono 19 mm	Filetto 9,5 mm	M 14 x 1,25	Conf.10 pz
BPM 7 A	Esagono 19 mm	Filetto 9,5 mm	M 14 x 1,25	Conf.10 pz
BPMR 6 A	Esagono 19 mm	Filetto 9,5 mm	M 14 x 1,25	Conf.10 pz
BPMR 7 A	Esagono 19 mm	Filetto 9,5 mm	M 14 x 1,25	Conf.10 pz
BPMR 8 Y	Esagono 19 mm	Filetto 9,5 mm	M 14 x 1,25	Conf.10 pz
BPR 5 ES	Esagono 21 mm	Filetto 19,0 mm	M 14 x 1,25	Conf.10 pz
BPR 6 ES	Esagono 21 mm	Filetto 19,0 mm	M 14 x 1,25	Conf.10 pz
CR 5 HSB	Esagono 16 mm	Filetto 12,0 mm	M 10 x 1,00	Conf.10 pz
CMR 5 H	Esagono 16 mm	Filetto 12,0 mm	M 10 x 1,00	Conf.10 pz
CMR 6 A	Esagono 16 mm	Filetto 9,5 mm	M 10 x 1,00	Conf.10 pz
CMR 6 H	Esagono 16 mm	Filetto 12,0 mm	M 10 x 1,00	Conf.10 pz
CMR 7 A	Esagono 16 mm	Filetto 9,5 mm	M 10 x 1,00	Conf.10 pz
CMR 7 H	Esagono 16 mm	Filetto 12,0 mm	M 10 x 1,00	Conf.10 pz



B P R 5 E S - 11

Unità. mm

B		P		R		5		E		S		-11		
	Diametro filettatura	esagono	Struttura		Resistore		Grado termico		Lunghezza filettatura		Caratteristiche costruttive		Gap	
A	∅ 18,0	Hex 25,4	P	punta isolatore prominente	R	Candela resistiva	2	 candela calda	E	19,0	B	terminale SAE fisso (CR8EB)	vuoto	Motociclo :
B	∅ 14,0	Hex 20,8			Z	resistenza induttiva	4		EF	17,5	CM	Elettrodo di massa in esecuzione obliqua Tipo compatto (lunghezza isolante visibile: 18,5)		
BC	∅ 14,0	Hex 16,0	M	Candela compatta del tipo Bantam			5		EH	19,0 (parzialmente filettata)	CS	Elettrodo di massa in esecuzione obliqua	-8	0,8
BK	∅ 14,0	Hex 16,0					6		H	12,7	G, GV	Candela Racing	-9	0,9
C	∅ 10,0	Hex 16,0	U	Candela a scarica superficiale o semisuperficiale			7		L	11,2	I	Elettrodo all'iridio	-10	1,0
D	∅ 12,0	Hex 18,0					8		vuoto	Sede conica A(P)-F : 10,9 B(P)-F : 11,2 BM(P)-F : 7,8	IX	Candela Iridium IX	-11	1,1
DC	∅ 12,0	Hex 16,0					9				Candela del tipo piccolo B(P)-M : 9,5 B-LM : 9,5 CM- : 9,5 C-60 : 8,5	J	2 elettrodi di massa estesi	-13
E	∅ 8,0	Hex 13,0					10					K	2 elettrodi di massa	-15
*Eccezione B(P)M A, Y : ∅ 14,0, Hex 19,0 R(P)-(E)F : ∅ 14,0, Hex 16,0 CM 6 - ∅ 10,0, Hex 14,0														
BC : Misura standard JIS precedente La lunghezza della guarnizione del circuito al terminale è di 53 mm.														
BK : Misura standard ISO / JIS La lunghezza della guarnizione del circuito al terminale è di 50,5 mm.														
-LM Tipi compatti (lunghezza isolatore: 14,5)														
N elettrodo di massa irrobustito														
P elettrodo al platino Elettrodo di massa singolo: Platino doppio Elettrodo di massa multiplo. Elettrodo centrale singolo in platino														
Q 4 elettrodi di massa														
S Tipo standard														
T 3 elettrodi di massa														
U Tipo a scarica semi-superficiale														
Y Elettrodo centrale scanalato a V -V grooved-														
Z struttura speciale														
-S guarnizione anulare speciale														
-E Resistenza speciale														
IX-P Candela all'Iridio MAX														
LPG 1-8 Gamma di candele LaserLine per motori a gas														



PER INDIVIDUARE CON LA MASSIMA PRECISIONE TIPO DI PRODOTTO, MARCA E MODELLO CONSULTARE IL SITO UFFICIALE NGK OPPURE DIGITARE IL SEGUENTE LINK:

<https://www.ngkntk.com/it/trova-componente/produtfinder/B/////article//>



MODULI ACCENSIONE

SIG



NOVA

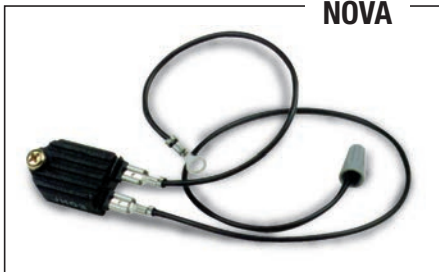

Sostituisce contatti e condensatori sulla maggior parte dei piccoli motori a 2T e 4T raffreddati ad aria (motoseghe, decespugliatori, rasaerba, motopompe, ecc. di cilindrata non superiore a 40 cc). Non utilizzabile su motori con avviamento elettrico.

CA SIG Modulo transistorizzato d'accensione SIG-01

CA NOVA Modulo transistorizzato d'accensione NOVA

CONTAGIRI E MANOMETRI

MS 4 VRF



MS 8



MS 4 VRF

Contagiri digitale modello 4 VRF

MS 8

Manometro prova carburatori

REGOLAZIONE CARBURATORI

CC 5 KT

Kit giraviti composto da 5 differenti utensili per regolazione della maggior parte dei carburatori in uso



ATTACCHI CANDELA

- CC 50 61** Attacco candela standard con innesto a vite - Attacco mm 5
- CC 70 59** Attacco candela standard con innesto a vite - Attacco mm 7
- CC 50 62** Attacco candela completo di molla - Attacco mm 5
- CC 70 63** Attacco candela completo di molla - Attacco mm 7
- CC 50 58** Attacco candela in moplen con innesto - Attacco mm 5
- CC 70 60** Attacco candela in moplen con innesto - Attacco mm 7
- CC 80 57** Attacco candela super completo di innesto a vite
- CC 21 00** Attacco candela per motori Briggs & Stratton - 66538S - 7 mm
- CC 21 41** Attacco candela per motori Honda
- CC 21 50** Attacco candela per motori Honda 30600ZE1000 - 30700ZE1013
- CC 50 20** Attacco candela per Champion PRO-5U/200

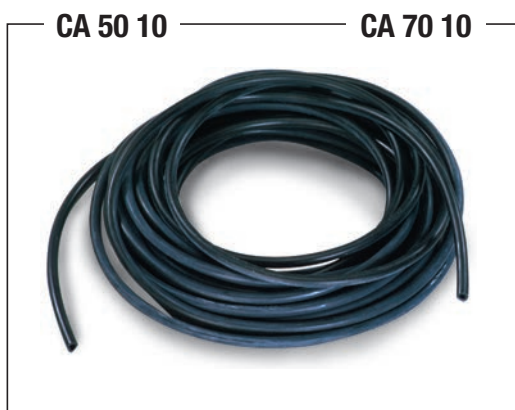

CAVI CANDELA

- CA 50 10**
Cavo candela standard - diametro mm 5 - Rotoli da 10 metri
- CA 70 10**
Cavo candela standard - diametro mm 7 - Rotoli da 10 metri

IMPUGNATURE AVVIAMENTO

IA 250



IA 280



IA 290



IA 300



IA 250 Impugnatura avviamento piccola per dec.

IA 280 Impugnatura avviamento standard

IA 290 Impugnatura avviamento tipo Stihl

IA 300 Impugnatura avviamento tipo Husqvarna

FUNE AVVIAMENTO

FA 280

Rotolo fune avviamento m 100 - mm 2,8

FA 300

Rotolo fune avviamento m 100 - mm 3,0

FA 350

Rotolo fune avviamento m 100 - mm 3,5

FA 400

Rotolo fune avviamento m 100 - mm 4,0

FA 450

Rotolo fune avviamento m 100 - mm 4,5

FA 500

Rotolo fune avviamento m 100 - mm 5,0

FA 280

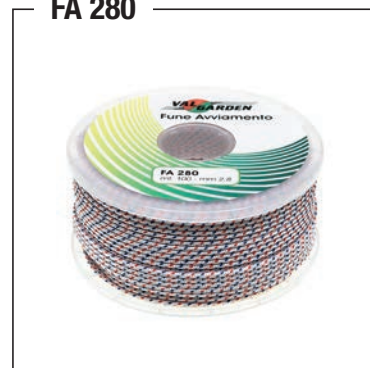

FA 300



FA 350



FA 400



FA 450



FA 500



PARTS CATALOG

MOTORI PER DECESPUGLIATORE

RICAMBI COMPATIBILI

CARBURATORE compatibile TJ-35

KWR 150040035

KWR 150040035



● KWR 150040035

CARBURATORE compatibile TJ-45

KWR 150040045

KWR 150040045



● KWR 150040045

CARBURATORE compatibile TJ-53

KWR 150040053

KWR 150040053



● KWR 150040053

CARBURATORE compatibile TH-48

KWR 150040048

KWR 150040048



● KWR 150030048

Kawasaki
— ENGINES —

KIT MEMBRANE compatibili TJ-27



● KWR 500000027

KIT MEMBRANE compatibili
TJ-35 TJ-45 TJ-53



● KWR 500000035

KIT MEMBRANE compatibili TH-34



● KWR 500000034

KIT MEMBRANE compatibili
TH-43 TH-48

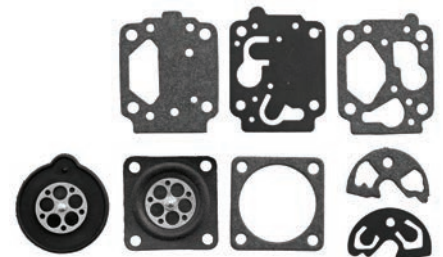

● KWR 500000043

PARTS CATALOG

MOTORI PER DECESPUGLIATORE

RICAMBI COMPATIBILI

SPILLO CONICO compatibile TJ-27

KWR 501001027

KWR 501001027



● KWR 501001027

SPILLO CONICO compatibile
TJ-35 TJ-45 TJ-53 TH-34

KWR 501001035

KWR 501001035



● KWR 501001035

SPILLO CONICO compatibile
TH-43 TH-48

KWR 501001043

KWR 501001043



● KWR 501001043

PRIMER compatibile
TJ-27 TJ-35 TJ-45 TJ-53

KWR 502002027

KWR 502002027



● KWR 502002027

PRIMER compatibile TH-34

KWR 502002034

KWR 502002034



● KWR 502002034

PRIMER compatibile
TH-43 TH-48

KWR 502002043

KWR 502002043



● KWR 502002043

Kawasaki
— ENGINES —

Kawasaki
— ENGINES —

KIT CILINDRO completo TJ-45

KWR 110050053
KWR 110050053



● KWR 110050045

PARTS CATALOG

MOTORI PER DECESPUGLIATORE

RICAMBI COMPATIBILI

FILTRO ARIA compatibile TJ-27

KWR 110130027

KWR 110130027



● KWR 110130027

FILTRO ARIA compatibile TJ-35

KWR 110130035

KWR 110130035



● KWR 110130035

FILTRO ARIA compatibile TJ-45

KWR 110130045

KWR 110130045



● KWR 110130045

FILTRO ARIA compatibile TJ-53

KWR 110130053

KWR 110130053



● KWR 110130053

FILTRO ARIA compatibile TH-34

KWR 110130034

KWR 110130034



● KWR 110130034

FILTRO ARIA comp. TH-43 TH-48

KWR 110134348

KWR 110134348



● KWR 110134348

KIT CILINDRO completo TJ-53

KWR 110050053

KWR 110050053



● KWR 110050053

KIT CILINDRO completo TH-43

KWR 110050043

KWR 110050043



● KWR 110050043

KIT CILINDRO completo TH-48

KWR 110050048

KWR 110050048



● KWR 110050048

PARTS CATALOG

MOTORI PER DECESPUGLIATORE

RICAMBI COMPATIBILI

FRIZIONE compatibile
TJ-35 TJ-45 TH-34 TH-43



● KWR 130810000

FRIZIONE compatibile TJ-53



● KWR 130810053

Kawasaki
— ENGINES —

BOBINA ACCENSIONE compatibile
TJ-35

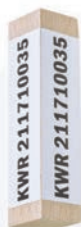

● KWR 211710035

BOBINA ACCENSIONE compatibile
TJ-45

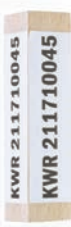

● KWR 211710045

BOBINA ACCENSIONE compatibile
TJ-53



● KWR 211710053

Kawasaki
— ENGINES —

CARTER AVVIAMENTO COMPLETO
compatibile TJ-45



● KWR 490880045

CARTER AVVIAMENTO COMPLETO
compatibile TJ-53



● KWR 490880053